



Operating the THERMOMARK CARD 2.0 thermal transfer printer for card material

User manual



User manual

Operating the THERMOMARK CARD 2.0 thermal transfer printer for card material

UM EN THERMOMARK CARD 2.0, Revision 01

2019-09-04

This user manual is valid for:

Designation

THERMOMARK CARD 2.0

Order No.

1085267

108770_en_01

PHOENIX CONTACT GmbH & Co. KG • Flachmarktstraße 8 • 32825 Blomberg • Germany
[phoenixcontact.com](https://www.phoenixcontact.com)

Table of contents

| | | |
|-------|---|----|
| 1 | For your safety | 5 |
| 1.1 | Identification of warning notes | 5 |
| 1.2 | Qualification of users | 5 |
| 1.3 | Field of application of the product | 6 |
| 1.4 | Safety notes..... | 6 |
| 2 | Starting up the printer | 8 |
| 2.1 | Unpacking and setup | 8 |
| 2.2 | Overview of the device | 9 |
| 2.3 | Connecting the device | 10 |
| 2.3.1 | Connecting the mains cable | 11 |
| 2.3.2 | Connecting the printer via USB | 12 |
| 2.3.3 | Connecting a printer via WLAN | 13 |
| 2.3.4 | Connecting a printer via Ethernet | 13 |
| 2.3.5 | Switching on the device | 14 |
| 2.3.6 | Creating print jobs | 14 |
| 2.4 | Inserting the material and printing..... | 15 |
| 2.4.1 | Inserting the ink ribbon | 15 |
| 2.4.2 | Inserting the magazine | 16 |
| 2.4.3 | Starting a print job | 17 |
| 2.4.4 | Inserting the material | 17 |
| 3 | Operating the printer | 18 |
| 3.1 | Touch screen display..... | 18 |
| 3.1.1 | Operating the display | 18 |
| 3.1.2 | Changing the language | 18 |
| 3.1.3 | Start page | 19 |
| 3.2 | Operation via the menu..... | 19 |
| 3.3 | Configuration via the website..... | 25 |
| 3.4 | Printing via FTP | 26 |
| 3.4.1 | FTP login | 26 |
| 3.4.2 | Sending print data via FTP | 26 |
| 3.4.3 | FTP access to storage media | 27 |
| 3.4.4 | FTP firmware update | 27 |

| | | |
|-----|---------------------------------------|----|
| 4 | Maintenance and troubleshooting | 28 |
| 4.1 | Cleaning the device | 28 |
| 4.2 | Cleaning the printhead..... | 29 |
| 4.3 | Troubleshooting..... | 30 |
| 4.4 | Error messages | 31 |
| 4.5 | Repairs | 32 |
| 4.6 | Storage and disposal..... | 32 |
| A | Appendix | 33 |
| A 1 | Ordering data..... | 33 |
| A 2 | Technical data | 36 |
| A 3 | Approvals and declarations | 38 |
| A 4 | Declaration of conformity..... | 39 |
| A 5 | Index..... | 41 |

1 For your safety

Read this user manual carefully and keep it for future reference.

1.1 Identification of warning notes



This symbol indicates hazards that could lead to personal injury.

There are three signal words indicating the severity of a potential injury.

DANGER

Indicates a hazard with a high risk level. If this hazardous situation is not avoided, it will result in death or serious injury.

WARNING

Indicates a hazard with a medium risk level. If this hazardous situation is not avoided, it could result in death or serious injury.

CAUTION

Indicates a hazard with a low risk level. If this hazardous situation is not avoided, it could result in minor or moderate injury.



This symbol together with the **NOTE** signal word warns the reader of actions that might cause property damage or a malfunction.



Here you will find additional information or detailed sources of information.

1.2 Qualification of users

This user manual is addressed to persons, who are familiar with the relevant safety concepts for handling electrical machines. The persons must be able to recognize dangers.

1.3 Field of application of the product

The THERMOMARK CARD 2.0 is a thermal transfer printer for the industrial sector. The printer can be used to print on plastic labels in card and sheet format.

With thermal transfer printing, heat causes the color layer of an ink ribbon to be transferred onto the card material.

The result of the print depends essentially on the suitable combination of material and ink ribbon. A low-quality ink ribbon can lead to premature wear on the printhead and result in a poor print image. Use only print materials from Phoenix Contact.

You may only use the printer with Phoenix Contact materials which are intended for the THERMOMARK CARD 2.0. The use of other materials can result in damage to the unit.

Do not use the device at locations where children may be present.

1.4 Safety notes

Life-threatening danger from mains voltage

Never open the housing of the device.

Risk of injury

If you operate the device with the cover open, rotating parts are exposed. The moving parts can catch on loose clothing, jewelry or hair.

The device has openings that are large enough for a child's finger to fit through. Do not use the device at locations where children may be present.

Danger of crushing from cover

Make sure you do not crush yourself with the cover.

Risk of burns

During operation, the printhead can get hot. Allow the printhead to cool down before you change the ink ribbon or clean the printhead line.

Hazard to operational safety

Incorrect operation or modifications to the device can endanger your safety or damage the device. Do not repair the device yourself. If the device is defective, please contact Phoenix Contact.

Damage to the device

- Only operate the device in locations that are dust-free as far as possible, dry and protected against splashwater.
- Protect the device and materials from humidity, damp, and dirt.
- Do not expose the device to direct sunlight.
- The device is equipped with a wide range power supply unit for AC voltages between 100 V and 240 V. The electrical connection conditions must comply with the details on the rating plate.

Radio interference

This is a Class A item of equipment (EN 55032). When using the equipment in residential areas, it may cause radio interference. In this case, the operator is obligated to take appropriate measures.

Notes on the printhead

The printhead is the most sensitive part of your printer. Improper handling can damage the printhead.

During printing, always make sure that there is no contamination on the material as this could be pulled underneath the printhead. This can damage the printhead.

The ink ribbon must be at least 5 mm wider than the material. Direct contact between the printhead and the material can lead to increased wear on the printhead.

2 Starting up the printer

2.1 Unpacking and setup

Scope of supply

- Printer
- Mains cable
- USB cable
- THERMOMARK-RIBBON 110/50 ink ribbon
- Empty film core (possibly already mounted on the take-up hub)
- THERMOMARK CARD UCT-MAG 1 and THERMOMARK CARD US-MAG 1 magazines
- UCT and US printing samples
- UCT-TM 6 and US-EMLP (85,6x54) materials
- Package of cotton buds for cleaning the printhead
- Data carrier with download link for the driver. The data carrier also contains this user manual in several languages.
- User manual in German and English

Unpacking

- Check the device for damage which may have occurred during transport.
- Retain the original packaging for subsequent transport.



When transporting the printer, you must remove the ink ribbon and the magazine.

Unlocking the transportation safeguard



Figure 2-1 Unlocking the transportation safeguard

- Move the slider to the  position.

Requirements for the installation location



NOTE: Damage to the device

Only operate the device in locations that are dust-free as far as possible, dry and protected against splashwater. Protect the device and materials from humidity, damp, and dirt. Do not expose the device to direct sunlight.

- Place the device on a level surface.

2.2 Overview of the device

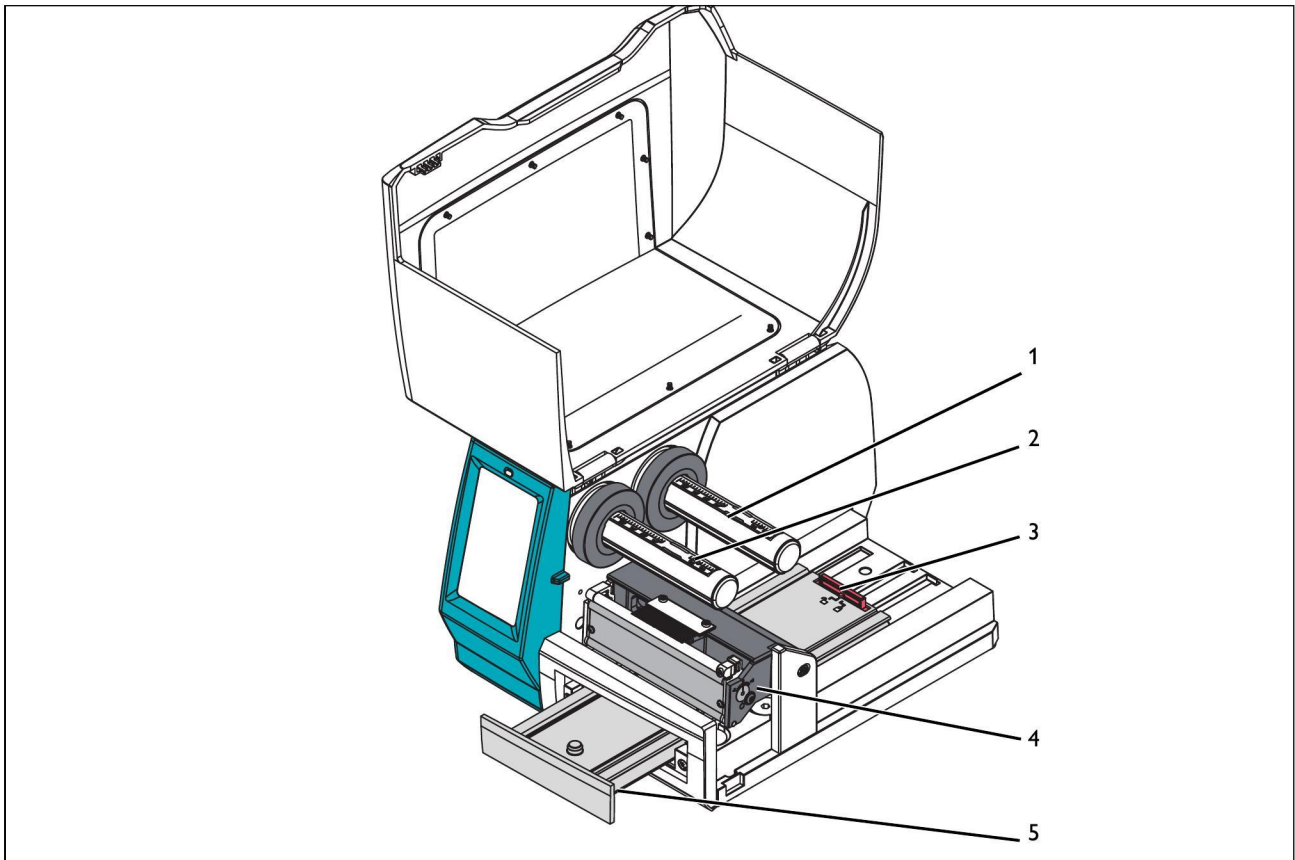

Figure 2-2 Overview

- 1 **Supply hub**, for supplying the ink ribbon
- 2 **Take-up hub**, for winding the ink ribbon
- 3 **Transportation safeguard**
- 4 **Printing unit**
- 5 **Compartment**

2.3 Connecting the device

Mains and computer connections

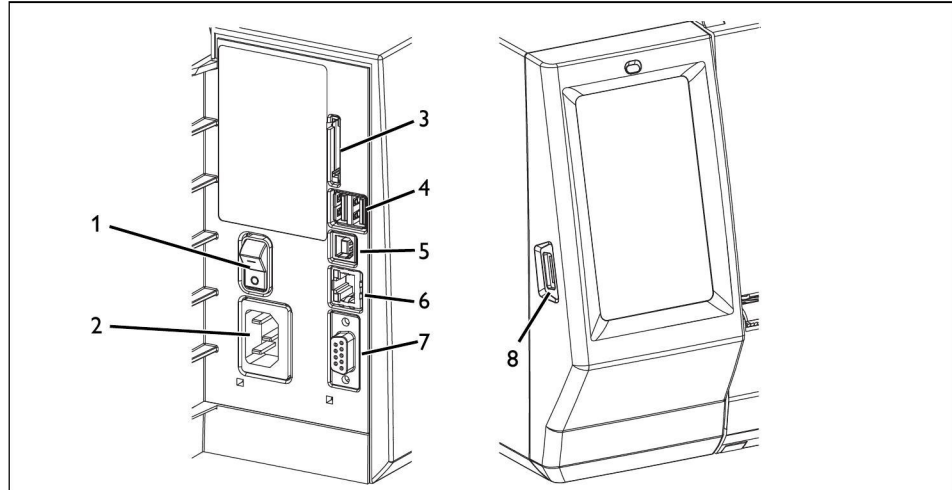

Figure 2-3 Connections on the rear of the device

- 1 Power supply switch
- 2 Mains socket
- 3 SD card slot
- 4 Two USB master interfaces for keyboard, scanner, USB memory device and WLAN stick
- 5 USB slave interface, full-speed, for connection to a computer
- 6 Ethernet 10/100Base-T
- 7 RS-232 interface
- 8 USB master interface for keyboard, scanner, USB memory device, WLAN stick and Bluetooth adapter

Errors can occur during operation due to insufficient or missing grounding. Make sure that all devices and cables connected to the printer are grounded.

Before connecting or disconnecting devices or cables, switch off the printer and the connected devices. USB connections can be established and disconnected when the printer is switched on.

2.3.1 Connecting the mains cable

The THERMOMARK CARD 2.0 is equipped with a wide range power supply unit for AC voltages between 100 V and 240 V.

To comply with the electromagnetic compatibility regulations, you must attach the included ferrite sleeve to the mains cable.

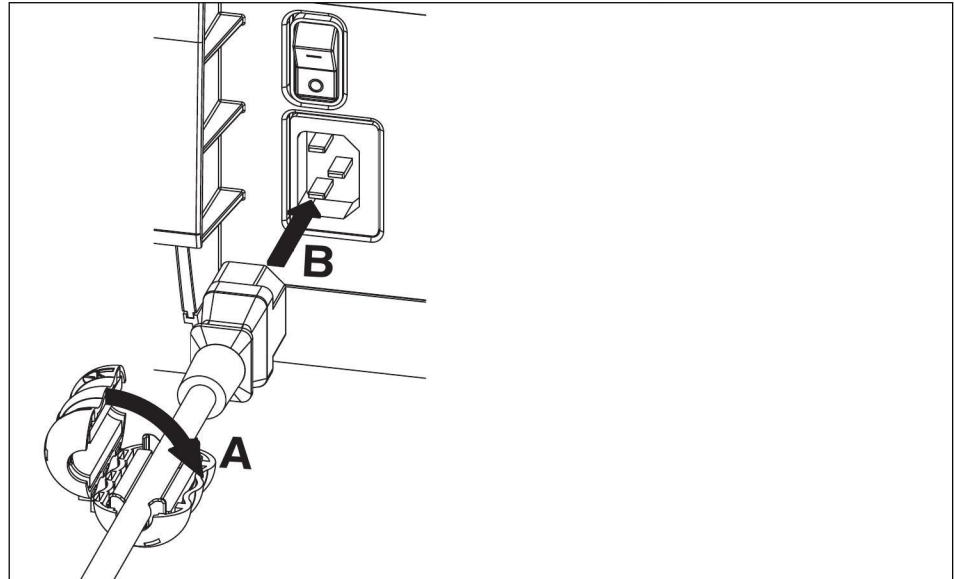

Figure 2-4 Connecting the mains cable

- Attach the supplied ferrite sleeve to the mains cable.
- Insert the mains cable into the socket of the device.
- Connect the mains cable to a socket.

2.3.2 Connecting the printer via USB



NOTE: Malfunctions during operation due to insufficient or missing shielding

Ensure that all cables connected to the device are shielded.

A driver must be installed in order to operate the printer. You will find a link to the driver on the data carrier included in the scope of supply. The driver can also be found on the Internet at phoenixcontact.net/qr/1085267.

- Switch on the computer.
- Exit all programs that are currently running.
- Switch on the device.
- Connect the computer and device with the supplied USB cable.
- Download and install the driver software.

Following successful installation, an icon for the THERMOMARK CARD 2.0 appears in the Windows “Devices and Printers” system folder.

- Open the marking software.
 - CLIP PROJECT can be downloaded at phoenixcontact.net/qr/5146053.
 - PROJECT complete can be downloaded at phoenixcontact.net/qr/1050453.

CLIP PROJECT marking

- Open “File, Print setup...” and create a new device under “Thermo, THERMOMARK CARD 2.0”.
- Set up the device in the marking software.
You can find CLIP PROJECT marking instructions at phoenixcontact.net/qr/5146040.

PROJECT complete marking

- Open “File, Printer Configurations” and select the THERMOMARK CARD 2.0 printer in the “New” field.
- Select the THERMOMARK CARD 2.0 from the field with available printers.
- Set up the device in the marking software.

2.3.3 Connecting a printer via WLAN

Installing a WLAN stick

- Insert a WLAN stick into the USB interface to the left of the display.

Setting up the WLAN connection

- Activate the WLAN interface via the menu (see “Setting up WLAN” on page 21).
- Select Access Point. The search for available access points starts. The available access points, including hidden access points, are shown on the display.
- Select the access point. To use a hidden access point, enter its SSID.
- Assign an IP address with subnet mask and gateway or select DHCP.
When you configure a WLAN connection via the website, do not change the “IP” and “Gateway” parameters. Otherwise, the connection to the printer is interrupted.
- For protected networks, the network key is requested. Enter the network key. The connection is established. The network name and IP address are displayed.

2.3.4 Connecting a printer via Ethernet

To connect a printer via the Ethernet interface, use a cable with RJ45 connectors and the 10Base-T or 100Base-T transmission standard. Use a shielded cable.

- Connect the printer to a network socket or a computer.
- Set up the Ethernet interface via the menu (see “Setting up Ethernet” on page 21).

When you configure a WLAN connection via the website, do not change the “IP” and “Gateway” parameters. Otherwise, the connection to the printer is interrupted.

2.3.5 Switching on the device

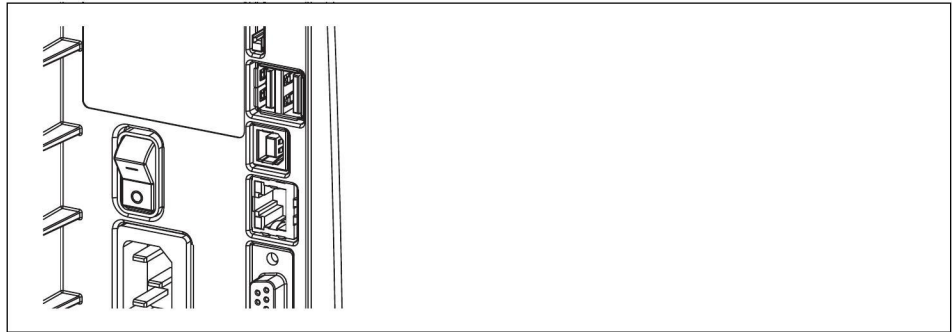

Figure 2-5 Switching on the printer

- Before switching on the printer, unlock the transportation safeguard (see “Unpacking” on page 8).
- Switch on the printer using the mains switch on the rear of the device. The printer runs a system test. It indicates that it is ready for operation.

2.3.6 Creating print jobs

Create the print jobs using the CLIP PROJECT or PROJECT complete marking software. The marking software can be used to create markings on the computer that are adapted to the Phoenix Contact marking material.

Select the THERMOMARK CARD 2.0 as the output device there. You will be provided with a list of materials that are suitable for this device.

- CLIP PROJECT can be downloaded at phoenixcontact.net/qr/5146053.
- PROJECT complete can be downloaded at phoenixcontact.net/qr/1050453.

2.4 Inserting the material and printing

2.4.1 Inserting the ink ribbon

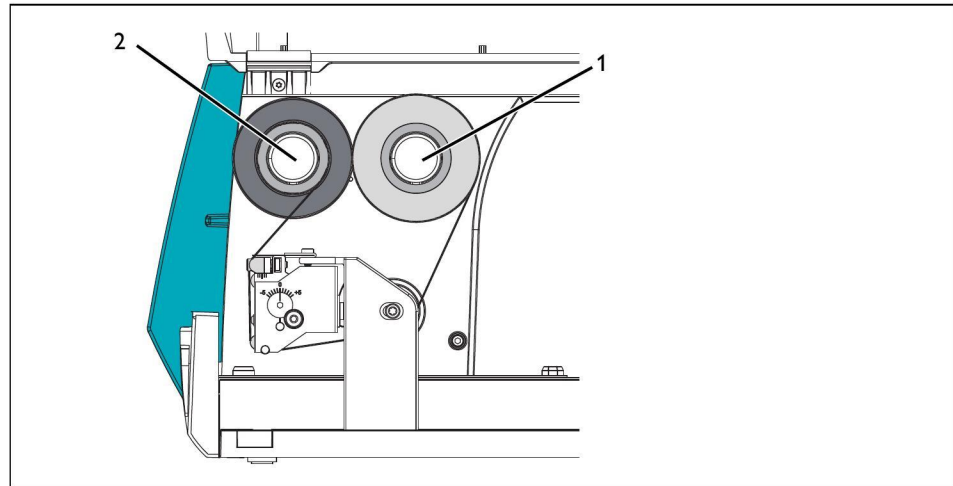

Figure 2-6 Feed path of the ink ribbon

Clean the printhead before inserting the ink ribbon (see “[Cleaning the printhead](#)” on [page 29](#)).

Inserting the ink ribbon

- Push the ink ribbon roll onto the supply hub (1) so that the color coating of the film faces downwards during unwinding.
- The Phoenix Contact ink ribbon rolls for this printer have the color coating on the outside of the winding. Observe the unwinding direction shown in [Figure 2-6](#). **If the color coating is positioned incorrectly, the film will stick to the printhead.**
- Push the empty core of an ink ribbon roll onto the take-up hub (2).
- Guide the ink ribbon through the printing unit as shown in [Figure 2-6](#).
- Secure the starting end of the ink ribbon centrally on the empty core of the ink ribbon roll using adhesive tape. Observe the counterclockwise running direction of the take-up hub.
- To tighten the feed path of the ink ribbon, turn the take-up hub counterclockwise.

2.4.2 Inserting the magazine



Suitable material

- **Magazine** for:
 - UCT material: THERMOMARK CARD UCT-MAG 1
 - UM material: THERMOMARK CARD UM-MAG 1
 - US material: THERMOMARK CARD US-MAG 1



CAUTION: Danger of crushing

When the compartment is moved in and out, make sure that no parts of the body or objects are within the working range of the compartment.

- Move the compartment out. To do this, touch the  button on the display.
- Place the magazine into the locators in the compartment.
- Lower the magazine until it is caught by the pins and rests on the compartment.
- Close the compartment using the  button on the display.

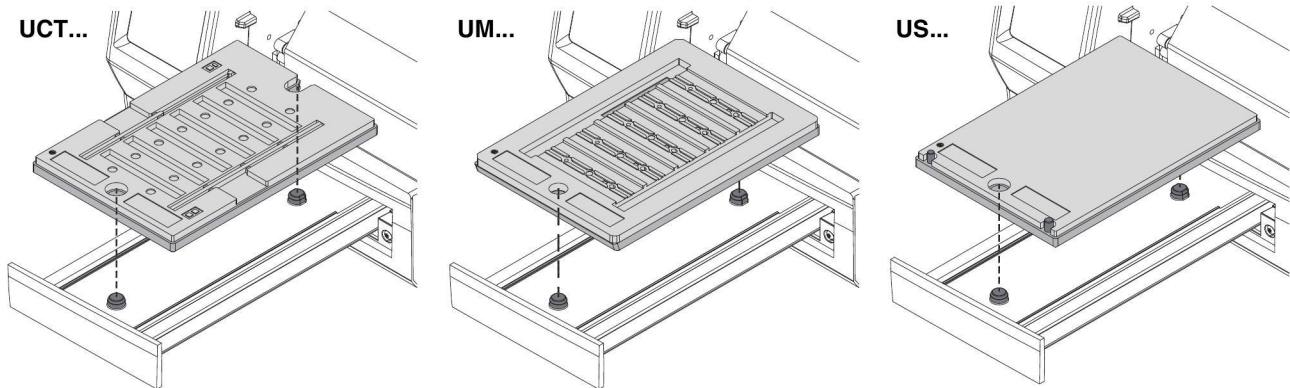



Figure 2-7 Inserting the magazine

2.4.3 Starting a print job

- Before switching on the printer, unlock the transportation safeguard (see “Unlocking the transportation safeguard” on page 8).
- Start a print job. You can also start a test print via the display (see “Test print” on page 23).
The material to be inserted appears on the display. Depending on the default setting, the compartment is moved out automatically (see “Compartment opens in case of print job” on page 20).
- Move the compartment out, if necessary. To do this, touch the  button on the display.
- Insert a magazine appropriate for the print job.

2.4.4 Inserting the material



NOTE: Damage to the printhead

Make sure that the material is not contaminated in any way. The material must be free of grease, fingerprints, and dust, and it must be dry.

- Insert the material in the magazine. Note the orientation of the material.

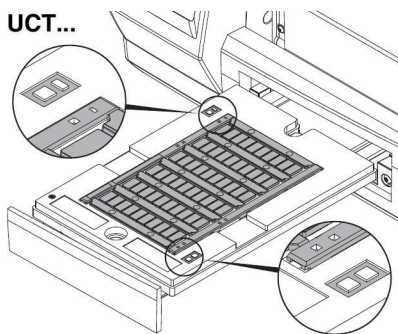

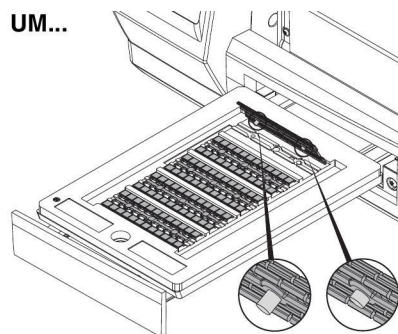

The square markings in the corners of the magazine and the material must line up.

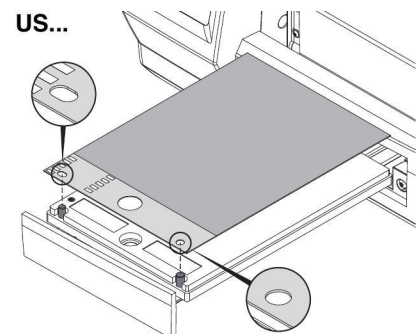

There are two pins of different length on the bottom of the UM material. The long pin must be on the left-hand side.



The material has two holes which fit over the pins in the magazine. The elongated hole must be on the left-hand side.

- You can print UCT, UM or US material even if one or more full strips are missing from the card. However, do not insert material with incomplete strips.
- Close the compartment using the  button on the display. The printer checks the material.
If the material is inserted correctly, printing is started. Once printed, the compartment is moved out again.
- Remove the material.
- Insert new material until the print job is complete.
- You can repeat the last printed page via the  button on the display.

3 Operating the printer

3.1 Touch screen display

You can change the basic settings of the printer via the touch screen display, for example:

- Pause, continue or cancel print jobs
- Configure interfaces
- Set language and time
- Update the firmware







Use only CLIP PROJECT or PROJECT complete software to modify print jobs.

3.1.1 Operating the display

- To select a menu item, briefly touch the corresponding icon.
- Move your finger up and down the display to scroll through lists.





3.1.2 Changing the language

The language is set when the printer is started up. To select a different language later, proceed as follows:

-  • Touch this icon.
-  • Touch this icon.
-  • Touch this icon.
-  • Touch this icon.
- Touch the desired language.

3.1.3 Start page

Not always are all icons visible. An icon is hidden if it is not used in the current printer status.

-  Call the menu
-  Repeat last page printed
-  Delete all print jobs
-  Open and close the compartment

3.2 Operation via the menu

Table 3-1 Menu structure







|  | Menu | Setting option | Default |
|---|---|--|-------------------|
|  | Printer information | Printer type, version number and firmware creation date, serial number of CPU, operating time, and number of printed labels, printed length, IP and MAC addresses | – |
|  | Access to the storage medium | | – |
| | Can only be selected when an external storage medium is present | | |
| | If a storage medium is inserted, the following directories are created on the storage medium: /fonts, /images, /misc, /labels | | |
| |  | Open saved print jobs from the /labels directory on the external storage medium (SD card, USB stick) | – |
|  | Copy files between different storage media (SD card, USB stick) | – | |
|  | Select default storage medium | Specify storage medium to be accessed via the interfaces and FTP management. For other functions, all storage media can be selected but the default storage medium is suggested first. | USB memory device |
| | External storage media | <ul style="list-style-type: none"> – USB memory device – SD cards | |

Table 3-1 Menu structure













|  | Menu | Setting option [...] | Default |
|---|---|--|--|
|  | <p>Settings</p> <p></p> | <p>Changing printing parameters</p> <p> Setting the heat level If the printing quality is inadequate, you can change the value. We recommend increasing or reducing the heat level via the marking software first. – CLIP PROJECT: at “File, Print setup...” – PROJECT complete: at “File, Printer Configurations” You will find the “Printer parameters” under THERMOMARK CARD 2.0. Only change the setting in the printer after this has been done. This will result in an additional increase or reduction.</p> <p> Moving the print position horizontally This can also be changed via the marking software. – CLIP PROJECT: at “File, Print setup...” – PROJECT complete: at “File, Printer Configurations” You will find the “Printer parameters” under THERMOMARK CARD 2.0. The values from the printer and the marking software are added. The possible setting range in the printer is ±0.8 mm, maximum.</p> <p> Moving the print position vertically This can also be changed via the marking software. – CLIP PROJECT: at “File, Print setup...” – PROJECT complete: at “File, Printer Configurations” You will find the “Printer parameters” under THERMOMARK CARD 2.0. The values from the printer and the marking software are added. The possible setting range in the printer is ±1.5 mm, maximum.</p> <p> Compartment opens in case of print job If you do not want the compartment to move out for a print job, deactivate this function. This applies, e.g., if you cannot see the compartment.</p> <p> Repeat print by pressing the button There are several setting options. You can repeat the same print job or query the data again before.</p> | <p>0</p> <p>0.0 mm</p> <p>0.0 mm</p> <p>On </p> <p>Edit</p> |
|  | <p></p> | <p>Warning before end of ink ribbon</p> <p> Switching the warning that the ink ribbon is almost at its end on/off If the diameter of the ink ribbon roll falls below the value set here, a warning appears on the display. The possible setting range is indicated on the display.</p> | <p>Off </p> |

Table 3-1 Menu structure

























|  | Menu | Setting option [...] | Default |
|---|---|--|--|
|  |  | Setting up interfaces | |
| |  | Setting up Ethernet | |
| |  | Entering the host name Unique designation for the printer in the network | |
| |  | DHCP, method for assigning the IP address On: Dynamic assignment of the IP address by the DHCP server Off: Direct assignment of the IP address by the operator | On  |
| |  | Entering the IP address IP address of the label printer. Only visible when no DHCP server is active | - |
| |  | Entering the network mask Subnet mask of local network | - |
| |  | Switching on the gateway Connection between local and other networks | Off  |
| |  | Entering the IP address of a DNS server The DNS server resolves Internet addresses to IP addresses. This way, you can select network services such as NTP via the domain name, for example. | Off  |
| |  | Setting up WLAN | |
| | | Only visible when a WLAN stick is inserted | |
| |  | Activating the WLAN interface | Off  |
| |  | Search and selection of the access point to be used to establish the WLAN connection | - |
| |  | DHCP, method for assigning the IP address On: Dynamic assignment of the IP address by the DHCP server Off: Direct assignment of the IP address by the operator (see "Setting up Ethernet") | On  |
|  |  | Network services | |
| |  | Website | |
| |  | Activating the HTTP protocol for access to the printer-internal website (see "Configuration via the website") | On  |

Table 3-1 Menu structure























|  | Menu | Setting option [...] | Default |
|---|---|---|---|
|  |  | Printer behavior in case of error messages | |
| | |  On: after an error message, the last material is printed again Off: after an error message the next material is printed | On  |
| | |  In case of problems with the network connection, the printer is set to the error state Off: The printer ignores network problems | On  |
|  |  | Setting the language and country | |
| | |  Setting the language | English |
| | |  Setting the country Setting country-specific date and time formats | Germany |
| | |  Setting the keyboard layout when using an external keyboard When you select the automatic setting, the keyboard setting depends on the “Setting the country” parameter setting. | Automatic |
|  |  | Setting the time and date | |
| | |  Setting the time zone. The time zone is indicated with reference to UTC | UTC+1 |
| | |  Selecting the daylight savings time of a region. The time is automatically changed. | EU |
| | |  Setting the date in DD.MM.YYYY format The print output of the date is in the format set via the “Setting the country” parameter. | - |
| | |  Setting the system time in HH:MM:SS format When changing the time, ensure that the parameters for time zone, daylight savings time and date are correct. The print output of the time is in the format set via the “Setting the country” parameter. | - |
|  |  | Adjusting the display | |
| | |  Adjusting the brightness of the display | 8 |
| | |  Time without activity before the printer is set to energy-saving mode | 5 min |

Table 3-1 Menu structure























|  | Menu | Setting option [...] | Default |
|--|---|---|---------|
|  | Test print | | |
| |  | Test print on UCT-TM 6 | – |
| |  | Test print on US-EMLP (85,6x54) | – |
|  | Security | | |
| |  | Activating PIN protection, password for protection of print parameter changes via the display (default: 0000) | Off |
| |  | Password for printing via FTP (see page 26) FTP login as ftpprint | print |
| |  | Password for FTP access to a storage medium, such as a USB stick, SD card, IFFS FTP login as ftpcard | card |
| |  | Password for FTP firmware update FTP login as ftpadmin | admin |
|  | Password for setting parameters via the website Login as admin | admin | |

Table 3-1 Menu structure

|  | Menu | Setting option [...] | Default |
|---|---|--|---------|
|  | Extras | | |
| |  | Updating the firmware Copy the firmware file into the /misc directory of the storage medium. Insert the storage medium in the printer. Then click on this button. Select the file with the firmware. The printer restarts after the update. | – |
| |  | Saving the settings The current printer configuration is saved as an .xml file on a storage medium in the /misc directory. | – |
| |  | Loading the settings The printer configuration is loaded from the /misc directory of a storage medium to the printer | – |
| |  | Resetting With the exception of the passwords, all configuration settings are reset to the default values | – |
| |  | Setting the cleaning interval Setting the intervals for printhead cleaning depending on the material throughput in steps of 100 m The “Clean Printhead!” message appears on the display on two conditions: – Material of the set length has passed the printhead. – There is an error in the material flow (e.g., end of material, end of ink ribbon) As long as no error is present in the material flow, no message is displayed and the print job is continued even if the cleaning interval has expired. Only after you have acknowledged the “Clean Printhead!” message, the error message for the error that occurred in the material flow is displayed. | 1000 m |
|  | Licenses and software libraries for third-party components used in the firmware | – | |
|  | Watching help videos | | |
| |  | Video on how to insert the ink ribbon | – |
| |  | Video on how to insert the material | – |
| |  | Video on maintenance | – |
|  | Video on firmware update | – | |

3.3 Configuration via the website

All the parameters which are accessible via the display can also be configured via a website. The website is included in the printer's firmware. Use a browser (e.g., Microsoft Internet Explorer or Mozilla Firefox) with activated JavaScript.

Access the website via the Ethernet or WLAN interface.

Opening the website

To configure settings via the website, you must enter "admin" as the user name and a password. The default value for the password also is "admin".

You can change the password via the website.

- Start the browser.
- Open the website. Enter the IP address of the printer via HTTP (e.g., <http://192.168.9.10>).
A start screen appears.
- Use the mouse to click on the buttons. This way, you can operate the printer just like with the touch screen on the device.

Tabs on the website

The structure of the website corresponds to the menu structure of the printer.

- Reading status of printer
- Setting configuration parameters which are also accessible via the display in the "Settings" menu (see [page 20](#))
- Setting passwords
- Viewing lists of hardware and optional components
- Viewing overview of available fonts
- Opening auxiliary functions

3.4 Printing via FTP

With the File Transfer Protocol (FTP), you can manage and transfer files in the network via the Ethernet or WLAN interface. For printer management, you require an FTP program (FTP client) which supports the “binary” transfer mode. The printer acts as an FTP server.

The FTP printer management has three functions:

- Direct printing by copying from JScript files
- Management of the storage media installed on the label printer
- Firmware update

3.4.1 FTP login

To establish an FTP connection, the client must be logged in to the server. The type of login depends on the client. You must enter the following information in any case:

- IP address of the printer
- User name and password

Access to the printer management functions depends on the user name:

Table 3-2 Default passwords

| Function | User name | Default password ¹ |
|----------------------------------|-----------|-------------------------------|
| Printing via FTP | ftpprint | print |
| Access to storage medium via FTP | ftpcard | card |
| Firmware update via FTP | ftpadmin | admin |

¹ Change the passwords via the printer menu (see [page 23](#))

After logging in, you can access the FTP server in the same way you would access a Windows folder.

3.4.2 Sending print data via FTP

You can print the print data in JScript format via an FTP connection.

- Establish an FTP connection to the printer with the user name ftpprint and the specified password (default: print). An empty folder of the FTP server is displayed.
- Copy the label file in JScript format into the folder of the FTP server.
Printing of the label file starts immediately. After the print job is complete, the associated file is automatically deleted.
- End the FTP connection.

3.4.3 FTP access to storage media

Via FTP, you can edit files that are available on an installed storage medium.

- Establish an FTP connection to the printer with the user name ftpcard and the specified password (default: card).
The content of the storage medium is displayed. The files are divided into several subfolders according to the file type.
- Edit the files as necessary. When you copy files onto the FTP server, the files are automatically sorted into subfolders according to file type.
- End the FTP connection.

3.4.4 FTP firmware update

You can update the firmware via FTP.

- Establish an FTP connection to the printer with the user name ftpadmin and the specified password (default: admin). An empty folder of the FTP server is displayed
- Copy a valid firmware file (e. g., 500_6714.cfw) into the folder of the FTP server.
While the firmware is being copied, a progress indicator appears on the display. Once the file is successfully copied, the printer restarts automatically.
- End the FTP connection.

In the status display of the website, you can check whether the firmware update was successful.

4 Maintenance and troubleshooting



DANGER: Risk of electric shock

Disconnect the device from the power grid before carrying out any maintenance work.

4.1 Cleaning the device

- Protect the device from dust and other contaminants. If the device is not used, cover it.
- Wipe down the device with a duster. The duster can either be dry or dampened with a mild cleaning agent.
- Remove dust and paper fluff in the printing area with a soft brush or vacuum cleaner.
- It is important to clean the printhead regularly. This ensures consistently good printing and reduces wear on the printhead.
- We recommend to clean the printer once a month.

4.2 Cleaning the printhead

Cleaning periods

After a certain amount of material flow, a message on the display indicates that the printhead should be cleaned (see “Setting the cleaning interval” on page 24).

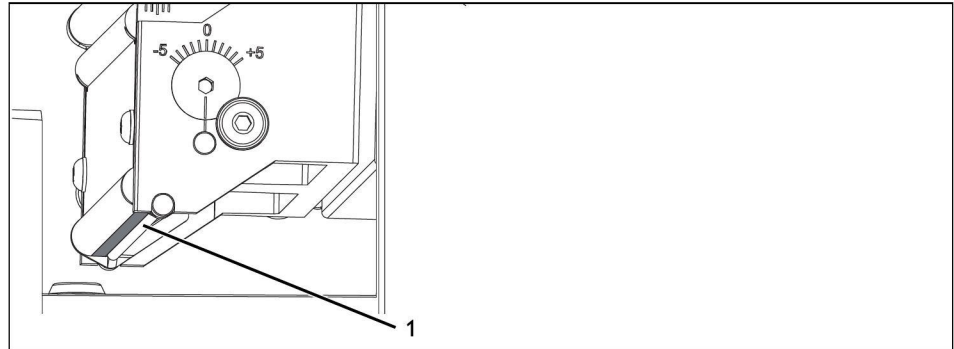

Figure 4-1 Printhead line

During printing, impurities can collect on the printhead and reduce the print quality.



WARNING: Risk of burns

During operation, the printhead can get hot. Allow the printhead to cool down before you change the ink ribbon or clean the printhead line.



NOTE: Damage to the printhead

Do not use sharp items (knives, screwdrivers etc.) to clean the printhead
The printhead has a protective layer in the lower front area. Do not touch this protective layer with your hand.
Do not touch the printhead line with your hand.

Switch off the device.

- Make sure that the printing unit has cooled down.
- Remove the material and the ink ribbon from the printer.
- Clean the printhead line (1) with a cotton bud soaked in alcohol. You can also use a cleaning stick (CLEANING STICK, 5146697).
- Let the printhead dry for 2 to 3 minutes.

4.3 Troubleshooting

Table 4-1 Troubleshooting

| Problem | Cause | Remedy | Page |
|--|-----------------------------------|---|----------|
| Ink ribbon wrinkles | Feed path of the ink ribbon | Check the ink ribbon path Check the horizontal position of the ink ribbon on the take-up hub and supply hub Reduce the heat for large areas | 15 |
| Print image is blurred or missing in places | Printhead is dirty | Clean the printhead | 29 |
| Printer transports the material but not the ink ribbon | Ink ribbon not inserted correctly | Clean the printhead Insert the ink ribbon correctly | 29 15 |
| Vertical white lines on the print image | Printhead is dirty | Clean the printhead | 29 |
| | Printhead is defective | Contact Phoenix Contact | – |
| Print image lighter on one side | Printhead is dirty | Clean the printhead | 29 |

4.4 Error messages

Table 4-2 Troubleshooting

| Error message | Cause | Remedy | Page |
|---------------------|--|--|------|
| "Printhead too hot" | Printhead has become overheated | The print job continues automatically after a pause | – |
| "Out of ribbon" | Ink ribbon used up | Insert new ink ribbon | 15 |
| | Ink ribbon torn during printing | Cancel the print job. Clean the printhead. | 29 |
| | | Insert the ink ribbon. Restart the print job. | 15 |
| | | Avoid horizontal lines across the full print width. | – |
| "Wrong media" | The inserted material does not match the preset material | Insert correct material. Select the inserted material in the marking software. | – |
| | The holes of the UCT magazine are dirty | Clean the holes in the UCT magazine. | – |
| "Voltage error" | Hardware fault | Switch printer off and on again. If this problem occurs again, contact Phoenix Contact | – |
| "Syntax error" | Printer has received an unknown or incorrect command | Skip command or cancel print job. | – |
| | | Check if the correct printer is set in the marking software. | – |

4.5 Repairs



WARNING: Hazard to operational safety

Incorrect operation or modifications to the device can endanger your safety or damage the device. Do not repair the device yourself. If the device is defective, please contact Phoenix Contact.

4.6 Storage and disposal

Transporting the device

- Remove the ink ribbon and the magazine.
- Make sure that the compartment is moved in completely.
- Lock the transportation safeguard.
- Pack the device in the original packaging for shipping.

Locking the transportation safeguard

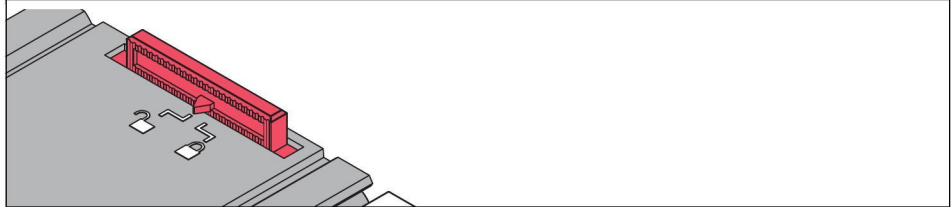



Figure 4-2 Locking the transportation safeguard

- Move the slider to the  position.

Storage

- Only store the device in dry surroundings.
- Store the device in such a way as to avoid any potential damage.
- Store the device completely with individual parts and accessories. Otherwise, key components could be missing when restarting the device.

Disposal



The device contains valuable recyclable materials, which should be utilized. The electronic circuit board is fitted with a lithium battery.

A Appendix

A 1 Ordering data

Thermal transfer printer

| Description | Type | Order No. | Pcs./Pkt. |
|---|---------------------|-----------|-----------|
| Thermal transfer printer for plastic labels in card and sheet format, including connecting cables, 300 dpi | THERMOMARK CARD 2.0 | 1085267 | 1 |

Ink ribbon

| Description | Type | Order No. | Pcs./Pkt. |
|--|-----------------------------|-----------|-----------|
| Ink ribbon , length: 50 m, width: 110 mm, color: black | THERMOMARK-RIBBON 110/50-TC | 0801384 | 1 |
| Ink ribbon , length: 300 m, width: 110 mm, color: black | THERMOMARK-RIBBON 110-TC | 0801371 | 1 |
| Ink ribbon , length: 60 m, width: 110 mm, color: white | TM-RIBBON 110 WH 100 | 0804661 | 1 |

Magazines

| Description | Type | Order No. | Pcs./Pkt. |
|--|---------------|-----------|-----------|
| US cards | TMP-US-MAG1 | 0803341 | 1 |
| UCT sheets , UCT-TM..., UCT1(U)-TM..., UCT5-TM..., UCT-EM (5X10) and (6X10) | TMP-UCT-MAG1 | 0803342 | 1 |
| UCT sheets , UCT-TMF... | TMP-UCT-MAG2 | 0803343 | 1 |
| UCT sheets , UCT-WMS... | TMP-UCT-MAG3 | 0803344 | 1 |
| UCT sheets , UCT1-TMF... | TMP-UCT-MAG4 | 0803345 | 1 |
| UCT sheets , UCT2-TM... | TMP-UCT-MAG5 | 0803347 | 1 |
| UCT sheets , UCT3-TM... | TMP-UCT-MAG6 | 0803348 | 1 |
| UCT sheets , UCT-WMT..., UCT-EM (7X10) | TMP-UCT-MAG7 | 0803349 | 1 |
| UCT sheets , UCT-EM (20X7), UCT-EM (17,5X8) | TMP-UCT-MAG8 | 0803350 | 1 |
| UCT sheets , UCT-EM (12X3,3), UCT-EM (12X6) | TMP-UCT-MAG9 | 0803351 | 1 |
| UCT sheets , UCT-EM (30X5) | TMP-UCT-MAG10 | 0803352 | 1 |
| UCT sheets , UCT-EM (17X10) | TMP-UCT-MAG11 | 0803353 | 1 |
| UCT sheets , UCT-EM (10X8), UCT-EM (12X7) | TMP-UCT-MAG12 | 0803354 | 1 |
| UCT sheets , UCT-EM (10X5) | TMP-UCT-MAG13 | 0803355 | 1 |
| UCT sheets , UCT-EM (17X8), UCT-EM (21X8) | TMP-UCT-MAG14 | 0803356 | 1 |
| UCT sheets , UCT-EM (20X9) | TMP-UCT-MAG15 | 0803357 | 1 |
| UCT sheets , UCT-EM (17X9) | TMP-UCT-MAG16 | 0803358 | 1 |
| UCT sheets , UCT-EM (18X8) | TMP-UCT-MAG17 | 0803360 | 1 |
| UCT sheets , UCT-EM (17,5X7,5) | TMP-UCT-MAG18 | 0803361 | 1 |
| UCT sheets , UCT-EM (15X10) | TMP-UCT-MAG19 | 0803363 | 1 |

THERMOMARK CARD 2.0

Magazines

| Description | Type | Order No. | Pcs./Pkt. |
|--|---------------|-----------|-----------|
| UCT sheets, UCT-EM (10X7), UCT-WMTB (29X8) | TMP-UCT-MAG20 | 0803364 | 1 |
| UCT sheets, UCT-EM (20X8) | TMP-UCT-MAG21 | 0803365 | 1 |
| UCT sheets, UCT-EM (17,5X9) | TMP-UCT-MAG22 | 0803366 | 1 |
| UCT sheets, UCT6M-TM... | TMP-UCT-MAG23 | 0803367 | 1 |
| UCT sheets, UCT6R-TM... | TMP-UCT-MAG24 | 0803368 | 1 |
| UCT sheets, UCT-WMCO ... (12X4) | TMP-UCT-MAG25 | 0803369 | 1 |
| UCT sheets, UCT-EMP... | TMP-UCT-MAG26 | 0803370 | 1 |
| UCT sheets, UCT-WMTBA... | TMP-UCT-MAG27 | 0803371 | 1 |
| UCT sheets, UCT-WMCO ... (18X4) | TMP-UCT-MAG28 | 0803372 | 1 |
| UCT sheets, UCT-WMCO ... (23X4) | TMP-UCT-MAG29 | 0803373 | 1 |
| UM strips, UM1-TM..., UM5-TM... | TMP-UM-MAG1 | 0831200 | 1 |
| UM strips, UM1-TMF... | TMP-UM-MAG3 | 0831202 | 1 |
| UM strips, UM1U-TM... | TMP-UM-MAG4 | 0831203 | 1 |
| UM strips, UM2-TM... | TMP-UM-MAG5 | 0803328 | 1 |
| UM strips, UM3-TM... | TMP-UM-MAG6 | 0803329 | 1 |
| UM strips, UM6M-TM... | TMP-UM-MAG7 | 0803330 | 1 |
| UM strips, UM6R-TM... | TMP-UM-MAG8 | 0803331 | 1 |
| UM strips, UM8-TM... | TMP-UM-MAG9 | 0803332 | 1 |
| UM strips, UM7-TM (5X10), UM7-TM (6X10) | TMP-UM-MAG10 | 0803334 | 1 |
| UM strips, UM7-TM (8X10) | TMP-UM-MAG11 | 0803681 | 1 |

Materials

| Description | Type | Order No. | Pcs./Pkt. |
|---|--------------|-----------|-----------|
| Terminal marking | | | |
| Sheet , mounting type: latching into a tall marker groove | UCT-TM... | | |
| Sheet , mounting type: latching into a tall marker groove, for marking third-party terminal blocks | UCT...-TM... | | |
| Card , mounting type: latching into a universal marker groove | US-TM... | | |
| Card , mounting type: latching into a universal marker groove, for marking third-party terminal blocks | US...-TM... | | |
| Markers in strip format , for terminal marking | UM-TM... | | |
| Markers in strip format , for terminal marking, for marking third-party terminal blocks | UM...-TM... | | |
| Wire marking | | | |
| Sheet , mounting type: clip-on | UCT-WM... | | |
| Card , mounting type: clip-on | US-WM... | | |
| Equipment marking | | | |
| Sheet , mounting type: latching into marker carrier | UCT-EM... | | |
| Card , mounting type: latching into marker carrier | US-EM... | | |
| Card , mounting type: latching into marker carrier, for marking third-party terminal blocks | US...-EM... | | |
| Card , mounting type: adhesive | US-EML... | | |
| Card , mounting type: adhesive | US-EMLP... | | |
| Card , mounting type: screws, rivets | US-EMSP... | | |

A 2 Technical data

| Printhead | |
|---|---|
| Printing method | Thermal transfer |
| Print resolution | 300 dpi x 300 dpi (11.81 dots/mm x 11.81 dots/mm) |
| Material sensor | Sensor for US, UCT and UM material |
| Print speed | 30 mm/s ... 75 mm/s |
| Print length | 140 mm, maximum |
| Print width | 104 mm, maximum |
| Material | |
| Print medium, maximum width | 115 mm |
| Print medium, maximum length | 164 mm |
| Ink ribbon | |
| Length | 300 m, maximum |
| Outside diameter of the ink ribbon roll | 68 mm, maximum |
| Internal core diameter | 25.4 mm |
| Ink side | Exterior |
| Printer dimensions | |
| Dimensions (W x H x D) | 189 mm x 320 mm x 253 mm |
| Weight | 6.5 kg |
| Electronics | |
| High-speed processor, 32 bits, ColdFire | |
| Cycle rate | 800 MHz |
| Main memory (RAM) | 265 MB |
| Program memory (ROM) | 50 MB |
| Slot for SD memory card (SDHC, SDXC) | Up to 512 GB |
| Interfaces | |
| USB 2.0 | High-speed slave for PC connection |
| USB host | 2 x on the back, up to 500 mA |
| Ethernet | LPD, IPv4, IPv6, RawIP printing, DHCP, HTTP, FTP, SMTP, SNMP, TIME, NTP, Zeroconf, SOAP web service |

Software

Marking software CLIP PROJECT marking advanced / professional
PROJECT complete marking

Operating data

Voltage 100 V AC ... 240 V AC, 50/60 Hz, PFC

Power consumption 100 W, maximum

Temperature

Operation +5°C ... +35°C

Storage 0°C ... +60°C

Transport -25°C ... +60°C

Humidity

Operation 10% ... 85%, non-condensing

Storage 20% ... 80%, non-condensing

Transport 20% ... 80%, non-condensing

Approvals

Approvals CE, FCC class A, UL, CB, CCC, KC, ICES3

A 3 Approvals and declarations

A 3.1 Federal Communications Commission (FCC)

NOTE: This equipment has been tested and found to comply with the limits for a Class A digital device, pursuant to Part 15 of the FCC Rules.

These limits are designed to provide reasonable protection against harmful interference when the equipment is operated in a commercial environment. The equipment generates, uses, and can radiate radio frequency and, if not installed and used in accordance with the instruction manual, may cause harmful interference to radio communications.

Operation of this equipment in a residential area is likely to cause harmful interference in which case the user may be required to correct the interference at his own expense.

A 3.2 Interference-Causing Equipment Standard (ICES)

Industry Canada Compliance Statement

This Class A digital apparatus complies with Canadian ICES-003.

CAN ICES-3 (A)/NMB-3(A)

A 3.3 GPL code

This product includes software code developed by third parties, including software code subject to the GNU General Public License ("GPL") or GNU Lesser General Public License ("LGPL"). As applicable, the terms of the GPL and LGPL, and information on obtaining access to the GPL Code and LGPL Code used in this product, are available to you at: phoenixcontact.net/products under the description of the printer.

The GPL Code and LGPL Code used in this product is distributed WITHOUT ANY WARRANTY and is subject to the copyrights of one or more authors. For details, see the GPL Code and the LGPL Code for this product and the terms of the GPL and LGPL.

Written Offer to GPL Source Code:

Whereas such specific license terms entitle you to the source code of such software, PHOENIX CONTACT will provide upon written request via email and/or traditional paper mail the applicable GPL source code files via CD-ROM for a nominal cost to cover shipping and media charges as allowed under the GPL and LGPL.

Please direct all inquiries to:

PHOENIX CONTACT GmbH & Co. KG
Flachmarktstraße 8
32825 Blomberg
DEUTSCHLAND

A 4 Declaration of conformity

The THERMOMARK CARD 2.0 complies with the key requirements of the following directives:

- 2011/65/EU Restriction of the use for certain hazardous substances
- 2014/30/EU EMC Directive (electromagnetic compatibility)
- 2014/35/EU Low Voltage Directive

The standards consulted for evaluating conformity can be found at:
phoenixcontact.net/product/1085267

A 5 Index

C

| | |
|------------------------------|----|
| Changing the language | 18 |
| Cleaning | |
| Device | 28 |
| Printhead | 29 |
| Cleaning interval | 24 |
| Cleaning the printhead | 29 |
| Connections | 10 |

D

| | |
|----------------|----|
| Display | 18 |
| Disposal | 32 |

E

| | |
|----------------------|--------|
| Error causes | 31 |
| Error messages | 31, 32 |
| Ethernet | 13 |

F

| | |
|-----------|----|
| FTP | 26 |
|-----------|----|

I

| | |
|-----------------------------|----|
| Ink ribbon | |
| Inserting | 15 |
| Ordering data | 33 |
| Inserting | |
| Ink ribbon | 15 |
| Magazine | 16 |
| Installation location | 8 |

M

| | |
|--------------------------|----|
| Magazine | |
| Inserting | 16 |
| Suitable magazines | 16 |

O

| | |
|---------------------|----|
| Ordering data | 33 |
|---------------------|----|

P

| | |
|----------------|----|
| Printhead | |
| Cleaning | 29 |
| Notes | 7 |

R

| | |
|---|-------|
| Removing the transportation safeguard | 8, 32 |
|---|-------|

S

| | |
|----------------------------|----|
| Scope of supply | 8 |
| Starting a print job | 17 |

T

| | |
|--------------------------------|----|
| Technical data | 36 |
| Transfer film | |
| See ink ribbon | 15 |
| Transport | 32 |
| Transportation safeguard | 32 |
| Troubleshooting | 31 |

U

| | |
|-----------------|---|
| Unpacking | 8 |
|-----------------|---|

W

| | |
|---------------|----|
| Website | 25 |
| WLAN | 13 |

Please observe the following notes

General Terms and Conditions of use for technical documentation

Phoenix Contact reserves the right to alter, correct, and/or improve the technical documentation and the products described in the technical documentation at its own discretion and without giving prior notice, insofar as this is reasonable for the user. The same applies to any technical changes that serve the purpose of technical progress.

The receipt of technical documentation (in particular user documentation) does not constitute any further duty on the part of Phoenix Contact to furnish information on modifications to products and/or technical documentation. You are responsible to verify the suitability and intended use of the products in your specific application, in particular with regard to observing the applicable standards and regulations. All information made available in the technical data is supplied without any accompanying guarantee, whether expressly mentioned, implied or tacitly assumed.

In general, the provisions of the current general Terms and Conditions of Phoenix Contact apply exclusively, in particular as concerns any warranty liability.

This manual, including all illustrations contained herein, is copyright protected. Any changes to the contents or the publication of extracts of this document are prohibited.

Phoenix Contact reserves the right to register its own intellectual property rights for the product identifications of Phoenix Contact products that are used here. Registration of such intellectual property rights by third parties is prohibited.

Other product identifications may be afforded legal protection, even where they may not be indicated as such.

How to contact us

Internet

Up-to-date information on Phoenix Contact products and our Terms and Conditions can be found on the Internet at:

phoenixcontact.com

Make sure you always use the latest documentation.

It can be downloaded at:

phoenixcontact.net/products

Subsidiaries

If there are any problems that cannot be solved using the documentation, please contact your Phoenix Contact subsidiary.

Subsidiary contact information is available at phoenixcontact.com.

Published by

PHOENIX CONTACT GmbH & Co. KG
Flachsmarktstraße 8
32825 Blomberg
GERMANY

Should you have any suggestions or recommendations for improvement of the contents and layout of our manuals, please send your comments to:

tecdoc@phoenixcontact.com



RSPSupply - 1-888-532-2706 - <https://www.RSPSupply.com>
See the product details here

PHOENIX CONTACT GmbH & Co. KG
Flachmarktstraße 8
32825 Blomberg, Germany
Phone: +49 5235 3-00
Fax: +49 5235 3-41200
E-mail: info@phoenixcontact.com
phoenixcontact.com

© PHOENIX CONTACT 2019-09-04

108770_en_01
Order No. — 01



RSPSupply - 1-888-532-2706 - <https://www.RSPSupply.com>
See the product details here